

ELECTRIC ROTARY POLISHER

NT09E-303

OPERATION MANUAL



**ONE
TECH**

ONETECH

Tools

ATTENTION! PLEASE READ THIS MANUAL BEFORE USING THE TOOL.



IMPROPER USE OF TOOL MAY CAUSE INJURY AND/OR PROPERTY DAMAGE!

ONLY QUALIFIED AND SPECIALLY TRAINED PERSONNEL FAMILIED WITH THESE INSTRUCTIONS IS ALLOWED TO USE AND MAINTENANCE OF THE TOOL.

Safety recommendations contained in present manual are in addition to general safety regulation in force in the region of tool usage, and do not replace it.



➤ **Risk of hit by moving parts.**

➤ **Increased noise and vibration level may occur.**

➤ **Risk of increased dust content in the air of working zone.**



➤ **Risk of fire and short circuit if the wire contacts source of fire and heat.**

➤ **Electric shock hazard.**



➤ **To reduce the risk of injury, user must read and understand operator's manual.**



1. IMPORTANT SAFETY INSTRUCTIONS

WORK AREA SAFETY

- Keep work area clean and well lit. Cluttered or dark areas invite accidents.
- Do not operate power tools in explosive atmospheres, such as in the presence of flammable liquids, gases or dust. Power tools create sparks, which may ignite the dust or fumes.
- Keep children and bystanders away while operating a power tool. Distractions can cause you to lose control.

ELECTRICAL SAFETY

- Power tool plugs must match the outlet. Never modify the plug in any way. Do not use any adapter plugs with earthed (grounded) power tools. Unmodified plugs and matching outlets will reduce risk of electric shock.
- Avoid body contact with earthed or grounded surfaces, such as pipes, radiators, ranges and refrigerators. There is an increased risk of electric shock if your body is earthed or grounded.
- Do not expose power tools to rain or wet conditions. Water entering a power tool will increase the risk of electric shock.
- Do not abuse the cord. Never use the cord for carrying, pulling or unplugging the power tool. Keep cord away from heat, oil, sharp edges or moving parts. Damaged or entangled cords increase the risk of electric shock.
- When operating a power tool outdoors, use an extension cord suitable for outdoor use. Use of a cord suitable for outdoor use reduces the risk of electric shock
- If operating a power tool in a damp location is unavoidable use a residual current device (RCD) protected supply.

PERSONAL SAFETY

- Stay alert, watch what you are doing and use common sense when operating a power tool. Do not use a power tool while you are tired or under the influence of drugs, alcohol or medication. A moment of inattention while operating power tools may result in serious personal injury.
- Use personal protective equipment. Always wear eye protection. Protective equipment such as a dust mask, non-skid safety shoes, hard hat or hearing protection used for appropriate conditions will reduce personal injuries.
- Prevent unintentional starting. Ensure the switch is in the off-position before connecting to power source and/or battery pack, picking up or carrying the tool. Carrying power tools with your finger on the switch or energizing power tools that have the switch on invites accidents.
- Remove any adjusting key or wrench before turning the power tool on. A wrench or a key left attached to a rotating part of the power tool may result in personal injury.
- Do not overreach. Keep proper footing and balance at all times. This enables better control of the power tool in unexpected situations.
- Dress properly. Do not wear loose clothing or jewelry. Keep your hair and clothing away from moving parts. Loose clothes, jewelry or long hair can be caught in moving parts.
- If devices are provided for the connection of dust extraction and collection facilities, ensure these are connected and properly used. Use of dust collection can reduce dust-related hazards.

- Do not let familiarity gained from frequent use of tools allow you to become complacent and ignore tool safety principles. A careless action can cause severe injury within a fraction of a second.

POWER TOOL USE AND CARE

- Do not force the power tool. Use the correct power tool for your application. The correct power tool will do the job better and safer at the rate for which it was designed.
- Do not use the power tool if the switch does not turn it on and off. Any power tool that cannot be controlled with the switch is dangerous and must be repaired
- Disconnect the plug from the power source and/or remove the battery pack, if detachable, from the power tool before making any adjustments, changing accessories, or storing power tools. Such preventive safety measures reduce the risk of starting the power tool accidentally.
- Store idle power tools out of the reach of children and do not allow persons unfamiliar with the power tool or these instructions to operate the power tool. Power tools are dangerous in the hands of untrained users.
- Maintain power tools and accessories. Check for misalignment or binding of moving parts, breakage of parts and any other condition that may affect the power tool's operation. If damaged, have the power tool repaired before use. Many accidents are caused by poorly maintained power tools.
- Use the power tool, accessories and tool bits etc. in accordance with these instructions, taking into account the working conditions and the work to be performed. Use of the power tool for operations different from those intended could result in a hazardous situation.
- Keep handles and grasping surfaces dry, clean and free from oil and grease. Slippery handles and grasping surfaces do not allow for safe handling and control of the tool in unexpected situations.

SERVICE

- Have your power tool serviced by a qualified repair person using only identical replacement parts. This will ensure that the safety of the power tool is maintained.

SPECIFIC SAFETY RULES FOR POLISHERS

- This power tool is intended to function as a polisher. Read all safety warnings, instructions, illustrations and specifications provided with this power tool. Failure to follow all instructions listed below may result in electric shock, fire and/or serious injury.
- Operations such as grinding, sanding, wire brushing or cutting-off are not recommended to be performed with this power tool. Operations for which the power tool was not designed may create a hazard and cause personal injury.
- Do not use accessories which are not specifically designed and recommended by the tool manufacturer. Just because the accessory can be attached to your power tool, it does not assure safe operation.
- The rated speed of the accessory must be at least equal to the maximum speed marked on the power tool. Accessories running faster than their rated speed can break and fly apart.
- The outside diameter and the thickness of your accessory must be within the capacity rating of your power tool. Incorrectly sized accessories cannot be adequately guarded or controlled.
- Threaded mounting of accessories must match the polisher spindle thread. For accessories mounted by flanges, the arbor hole of the accessory must fit the locating diameter of the flange. Accessories that do not match the mounting hardware of the power tool will run out of balance, vibrate excessively and may loss of control.
- Do not use a damaged accessory. Before each use inspect the accessory such as, backing pad for cracks, foam pads tear or excess wear. If power tool or accessory is dropped, inspect for damage or install an undamaged accessory. After inspecting and installing an accessory, position yourself and bystanders away from the plane of the rotating accessory and run the power tool at maximum no-load speed for one minute. Damaged accessories will normally break apart during this test time.
- Wear personal protective equipment. Depending on application, use face shield, safety goggles or safety glasses. As appropriate, wear dust mask, hearing protectors, gloves and workshop apron capable of stopping small abrasive or workpiece fragments. The eye protection must be capable of stopping flying debris generated by various operations. The dust mask or respirator must be capable of filtering particles generated by your operation. Prolonged exposure to high intensity noise may cause hearing loss.
- Keep bystanders a safe distance away from work area. Anyone entering the work area must wear personal protective equipment. Fragments of workpiece or of a broken accessory may fly away and cause injury beyond immediate area of operation.
- Never lay the power tool down until the accessory has come to a complete stop. The spinning accessory may grab the surface and pull the power tool out of your control.
- Do not run the power tool while carrying it at your side. Accidental contact with the spinning accessory could snag your clothing, pulling the accessory into your body.
- Regularly clean the power tool's air vents. The motor's fan will draw the dust inside the housing and excessive accumulation of powdered metal may cause electrical hazards.
- Do not operate the power tool near flammable materials. Sparks could ignite these materials.
- Do not use accessories that require liquid coolants. Using water or other liquid coolants may result in electrocution or shock.

- Kickback and Related Warnings Kickback is a sudden reaction to a pinched or snagged rotating pad, brush or any other accessory. Pinching or snagging causes rapid stalling of the rotating accessory which in turn causes the uncontrolled power tool to be forced in the direction opposite of the accessory's rotation at the point of the binding. For example, if a foam pad is snagged or pinched by the workpiece, the pad may either jump toward or away from the operator, depending on direction of the wheel's movement at the point of pinching. Pads may also break under these conditions. Kickback is the result of power tool misuse and/or incorrect operating procedures or conditions and can be avoided by taking proper precautions as given below.

Maintain a firm grip on the power tool and position your body and arm to allow you to resist kickback forces. Always use auxiliary handle, if provided, for maximum control over kickback or torque reaction during start-up. The operator can control torque reactions or kickback forces, if proper precautions are taken.

- Never place your hand near the rotating accessory. Accessory may kickback over your hand.
- Do not position your body in the area where power tool will move if kickback occurs. Kickback will propel the tool in direction opposite to the wheel's movement at the point of snagging.
- Use special care when working corners, sharp edges etc. Avoid bouncing and snagging the accessory. Corners, sharp edges or bouncing have a tendency to snag the rotating accessory and cause loss of control or kickback.
- Do not attach a saw chain woodcarving blade or toothed saw blade. Such blades create frequent kickback and loss of control.
- Safety Warnings Specific for Polishing Operations: Do not allow any loose portion of the polishing bonnet or its attachment strings to spin freely. Tuck away or trim any loose attachment strings. Loose and spinning attachment strings can entangle your fingers or snag on the workpiece.

ADDITIONAL SAFETY WARNINGS

WARNING!

To reduce the risk of injury, when working in dusty situations, wear appropriate respiratory.

- Always use common sense and be cautious when using tools. It is not possible to anticipate every situation that could result in a dangerous outcome. Do not use this tool if you do not understand these operating instructions or you feel the work is beyond your capability; contact ONETECH representative or a trained professional for additional information or training.
- Maintain labels and nameplates. These carry important information. If unreadable or missing, please contact ONETECH representative or service facility for assistance.

WARNING!

Some dust created by power sanding, sawing, grinding, drilling, and other construction activities contains chemicals known to cause cancer, birth defects or other reproductive harm. Some examples of these chemicals are:

- lead from lead-based paint
- crystalline silica from bricks and cement and other masonry products, and arsenic and chromium from chemically treated lumber. Your risk from these exposures varies, depending on how often you do this type of work. To reduce your exposure to these chemicals: work in a well-ventilated area, and work with approved safety equipment, such as those dust masks that are specially designed to filter out microscopic particles.

2. PRODUCT DESCRIPTION

2.1 Components



1. Accelerator Switch
2. Trigger Lock Button
3. Speed Control Dial
4. Spindle Lock Button
5. Backing Plate
6. Side Handle
7. Power Supply Cord (5 m)

2.2 Technical Data

Model	Rated speed, rpm	Input power, W	Input voltage, V ~	Backing plate, mm	Foam/Wool pad, mm	Net weight, kg	Output shaft
NT09E-303	700 – 2500	1200 (1800 max.)	220 – 240 (50/60 Hz)	125 – 150 (5" – 6")	150 – 180 (6" – 7")	2.2	M14

3. INTENDED USE

The machine is designed for polishing painted surfaces.

WARNING!

To guarantee electrical safety, the machine must not be damp or operated in a damp environment. The user bears the responsibility for damage and accidents caused by improper use.

4. FEATURES AND INSTALLATION

4.1 Electronics

1. Constant speed

The preselected motor speed is maintained on a constant level. Electronic controls ensure a steady cutting speed even when operating under different loads.

Note: The performance will be weakened in speed 5-6. The performance will also be weakened within low-speed load protection polisher.

2. Soft start

The smooth start-up ensures safety and reduces splash of polishing compound, extending the switch trigger and gear service life.

3. Stepless speed setting

Stepless speed setting meets multiply applications, the user can adjust speed according needs:

Speed 1-2: Even apply of polishing compound.

Speed 3-4: Elimination of scratches and marks.

Speed 5-6: Restoration of mirror shine.

WARNING!

Do not use power tool continuously in low speed for a long time to avoid overheating.

4. Accelerator switch

The power tool features an accelerator switch, the father you press the switch, the faster it will operate. The speed can be regulated steplessly between 300 rpm and the maximum speed preset on the speed control dial.

Note: The function only valid for power tool with an accelerator switch.

5. Double torque

The gear system with double reduction has double torque output and ultra-long service life for continuous work under load.

Note: The function only valid for power tool with the gear system of double reduction.

4.2 Install backing plate

Only use backing plate that is suitable for the maximum speed specified.

- Spindle lock
- Procedure
 1. Press the spindle stop button after polisher stops completely.
 2. Rotate the spindle to its locking position and lock it while pressing the button.
 3. Install or remove the backing plate from the spindle.

WARNING!

Do not press the spindle lock button when the machine is spinning! Otherwise, the machine will be damaged.

4.3 Attach polishing accessories

Ensure accurate attachment of foam/wool pad to backing plate by looking at the edge of polishing pad. If the polishing pad is offset, it may cause vibration.

WARNING!

Do not use large size polishing pad that exceed the design range of the machine.

4.4 Install Side Handle

Side handle can be installed on the left and right sides of the head of polisher as needed.

5. OPERATION

5.1 Power connection and start-up

The mains voltage and the frequency of the power source must correspond with the specifications on the machine's name plate.

When using machine with accelerator switch, the press = ON, release = OFF. The locking button can be engaged to operate in continuous mode. Press the switch again to release the knob.

When using the machine without accelerator switch, push forward switch block to start, press down switch block to stop.

5.2 Speed control

Generally, lower speeds are recommended for tight work areas and higher speeds are ideal for large surface areas.

Use the speed control dial to set the maximum speed for the application:

1. Set the speed control dial to the desired maximum speed.
2. Pull the trigger or push forward switch block.
3. Increase or decrease pressure on the trigger to vary the speed if fitted with accelerator switch block.
4. Use the trigger lock to LOCK ON the tool for continuous use, if desired.
5. To stop the tool, release the trigger or press down switch.

5.3 Guidance

- Do not work on the power tool if its electronics are defective as this may lead to excessive speeds. Defective electronics mean that there is no smooth start-up and the speed regulation fails.
- Do not overload the machine by pressing with excessive force! The best polishing results are achieved with moderate application pressure. The polishing capacity and quality are mainly dependent on the selection of the correct polish.
- Hold the machine with two hands, one on the motor housing and one on the gear head or additional handle to ensure safe guidance.

5.4 Polishing

- Always use side or bail handle for proper control. Move the polisher back and forth in long, sweeping strokes. Too much pressure, the wrong angle or improper motion may cause swirl marks or burning.
- For detailed polishing instructions, read the instructions provided with the finishes, waxes and polishes.

WARNING!

Rotary polishers are not allowed to work in speed 1-2 for a long time to avoid overheating. You can adjust to speed 3-6 to work continuously in normal time.

5.5 Preventing the paint from burning

- This can occur if you polish at high speed for long time or you allow the polishing pad to stay in one spot for even a long period of time. To prevent burning through paint, use very light pressure and keep the polisher moving constantly, especially when working near edges or where there are abrupt changes in the contour of the work surface.
- Be particularly careful when working at high speed which are more likely to burn through paint.

5.6 Preventing snagging

WARNING!

To reduce the risk of injury, please follow the instructions followed. Snagging can cause the tool to kick back, and lost of control.

- Snagging occurs when polishing pads get caught on rough edges of a work surface.
- Snagging can cause the tool to suddenly "kick back" and it may cause the pad to burn through the paint.
- To reduce the risk of snagging, use the polisher at low speeds when polishing rough surfaces. For tricky areas such as near trim or between a mirror and window on a car, do not take chances with a polisher. Polish these surfaces by hand.

6. MAINTENANCE AND CARE

6.1 Dust removal

Regularly clean the power tool and ventilation slots with air compressor. But not too close, or high-speed airstream damage internal parts.

6.2 Power cord

Don not bends the power cord at will. Check the power cord frequently and replace it in time if it is damaged.

6.3 Lubrication

Every 4-6 months or 200-300 hours of operation, the gearbox of the machine needs to be filled with lubricating oil. It is recommended to use Mobil EP1 lithium grease for filling.

6.4 Carbon brush

Every 2-3 months or 100-200 hours of operation, check whether the carbon brush of the machine is worn (you can observe through the ventilation slots whether there is obvious spark when the machine is in use). If obvious spark or the weakness of machine, stop using and replace the carbon brush immediately. Note: A carbon brush of the original factory is attached, please keep it properly.

WARNING!

Use only original carbon brush, low quality carbon brush may cause serious damage of motor.

7. CAUSES AND CORRECTIVE MEASURES

WARNING!

Always disconnect the mains plug from the socket before performing maintenance work on the machine!

7.1 If machine cannot start up, or work intermittently, check in following steps:

1. Check the power cord for broken, or the plug for damaged.
2. Check the carbon brush for worn out.
3. Check the wire inside the machine for loose or broken.
4. Check and replace the switch.
5. Check and replace the speed control dial.

7.2 Fails to adjust speed

Check and replace the speed control dial.

7.3 Abnormal sound

1. Check the gear for worn out.
2. Check the motor for iron scraping, which is usually accompanied by overheat or burnt smell (The iron scraping is caused by the deformation of the casing after heating, resulting in abnormal sound and high temperature of the machine).
3. Check the backing plate for lock in place.

7.4 Serious heating

1. Do not use the machine for a long time in low speed (1-2), which causes the motor to work slowly and poor heat dissipation, thus overheating the machine. You can set the machine in highest speed and idle it for a few minutes to reduce the temperature.
2. Frequent dusting of motors and air intakes.
3. Use backing plate of proper size. The polishing pad that over machine design-size is not allowed to use.

7.5 Obvious spark in the ventilation slots or weak power

1. Check the carbon brush for wear, change it if needed.
2. Check the motor for overheating and burning.
3. Check the cooper sheet in the armature for severe wear, change the armature if needed.

7.6 Strong smell of burning

1. Check the backing plate for lock in place and thread for match up.
2. Check the shaft of backing plate for loosing.
3. Check the bearing or shaft for wear.

7.7 Backing plate deflecting

1. Check the backing plate for lock in place and thread for match up.
2. Check the shaft of backing plate for loosing.
3. Check the bearing or shaft for wear.

8. ACCESSORIES

Original accessories

Use only high quality accessories for a maximum performance. Low quality accessories may cause serious machine imbalance that decreases the quality of the working results and increase machine wear.

9. ENVIRONMENT

Disposal

To protect the environment and human, damaged power tools must be recycled or reused in an environmentally friendly manner!

1. Do not dispose of electric power tools in household waste! Recycle devices, accessories and packaging. Observe applicable country-specific regulations.
2. Before scrapping of machine, be sure to cut off the power cord so that the machine cannot be reused.
3. For more information on product recycling, consult your local government, waste treatment center or dealer.

10. SERVICE

10.1 Warranty Service



















1. During the warranty period, Seller is only due to material defects in the product or process problems caused by the failure to give free repair, the user required warranty must be presented with purchasing bills and warranty cards, clear statement of the full name of the purchased product model, the body of the nameplate on the product code, the date of purchase, while providing the machine and accessories requires warranty, and are authorized by the maintenance center to verify, or do not have warranty rights.
2. During the warranty period, the following consumable parts are not covered by the warranty due to natural wear and tear in use:
 - Wear in service: commutator, carbon brush, bearing, bushing, gear, O-ring, etc.
 - Consumables: Power cord, plug, cable sheath, handle, housing, polishing pads, backing plate of sander, etc.
 - *Non-warranty parts and maintenance labor costs are the responsibility of user.
3. The following are not covered under warranty:
 - Failure to present a valid warranty card and proof of purchase, or the information on the warranty card does not match the physical object.
 - Damage caused by failure to use, maintain and store the product in accordance with the instructions for use.
 - Damage caused by drooping, water ingress, etc., due to improper use, storage or transportation.
 - Damage caused by failure to use original ONETECH parts (e.g. carbon brush).
 - The user disassembles, or causes damage by repairing, rebuilding, disassembling, or maintaining in non-ONETECH authorized service points.
 - Damage caused by forcing the brakes or exerting excessive pressure on power tools when they are operated at high speed.
 - Damage caused by starting a power tool without reaching a constant speed or stopping it completely before it starts to process a work piece or change functions.
 - Working in dusty or humid environments for long periods of time without timely maintenance due to the entry of foreign objects.
 - Battery damage caused by frequent under-charging or under-discharging of the battery or by being hit or changing the charger plug on its own.
 - ONETECH reserves the right to modify the above terms and conditions at any time without notice, and has the final interpretation of the above warranty terms.
 - Visit the official website www.onetech-tools.com for the latest product information

10.2 EXEMPTION FROM LIABILITY

The manufacturer and his representative are not liable for any damage and lost profit due to interruption in business caused by the product or by an unusable product.

The manufacturer and his representative are not liable for any damage which was caused by improper use of the power tool or by use of the power tool with products from other manufacturers.

11. DESCRIPTION OF SYMBOLS

	Before switching on the power tool, read the operating manual!
	Wear eye protection.
	Wear hearing protection.
	Wear protective gloves.
	Wear a dust mask.
	Wear protective clothes.
	Device is suitable for use indoors only. Store electric power tool in dry rooms.
	Caution / Warning.
	There is a risk of electric shock in case of incorrect use.
	Only charge the battery pack at temperatures between 4 °C to 40 °C. Protect the battery pack from heat, e.g. from continuous exposure of sunlight and fire.
	Do not throw device in the fire. There is a risk of explosion.
	Do not expose the device to rain; keep the device away from water.
	The product complies with the applicable European directives and an evaluation method of conformity for these directives was done.
	The product complies with the applicable requirements.
	The product complies with the applicable requirements.
	The product complies with the applicable requirements.
	Class II (double Insulated)
	Recycling can prevent the waste of potentially useful materials and reduce the consumption of fresh raw materials.
	Do not dispose of electric power tools with regular household waste! Power tools must be collected separately and recycled in an environmentally friendly manner.

CE DECLARATION OF CONFORMITY

We declare under our sole responsibility that the product described under “Technical Data” conforms to the following standards or normative documents:

- ✓ EN 62841-1
- ✓ EN 62841-2-4
- ✓ EN 61000-3-2
- ✓ EN 61000-3-3
- ✓ EN 55014-1
- ✓ EN 55014-2
- ✓ 2014/30/EU
- ✓ 2006/42/EC

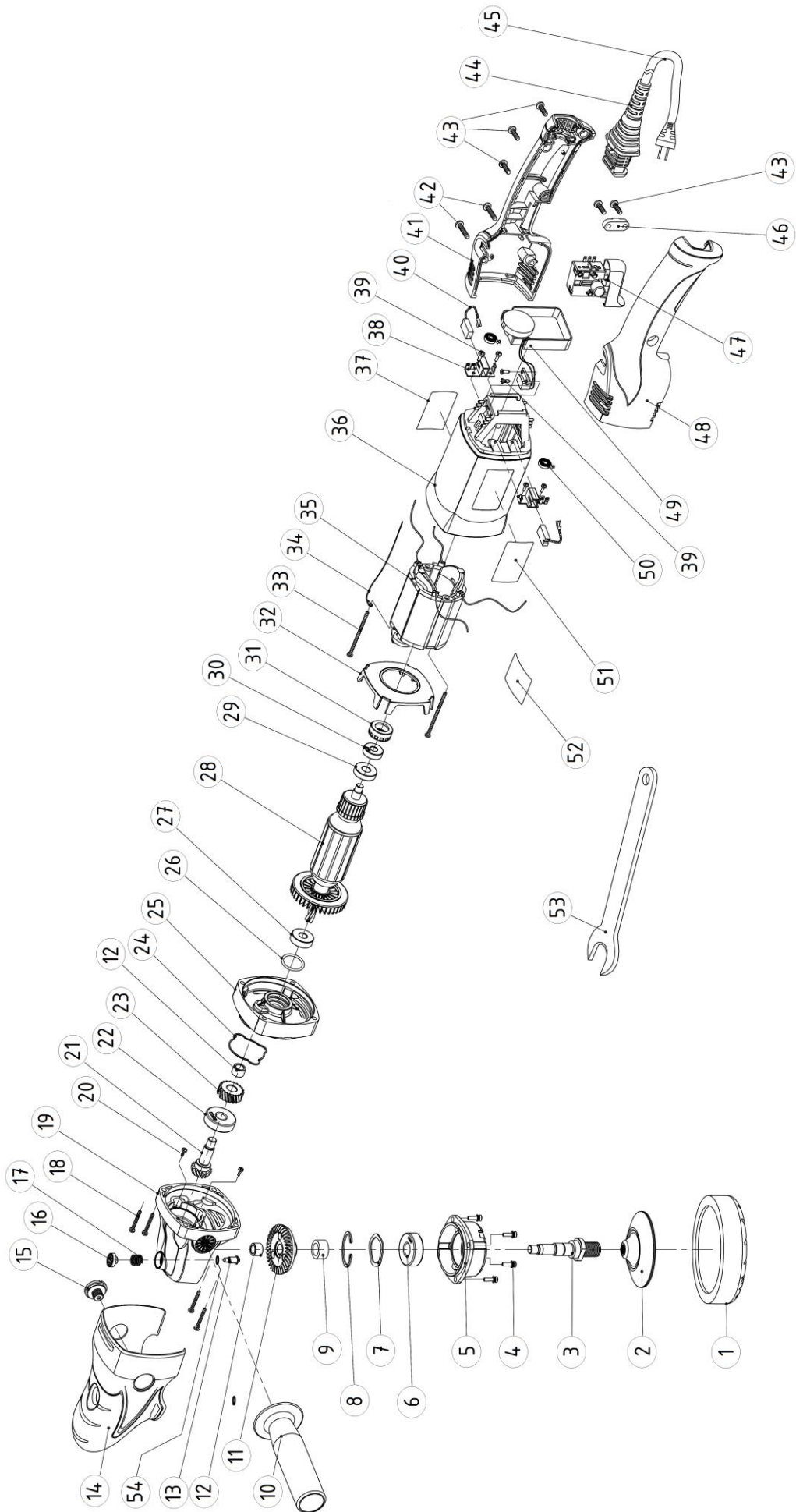

No.	Description	Part No.	Q'ty
1.	Foam/Wool pad (not included)	–	1
2.	Backing plate 150 mm (6")	NT06-6008	1
3.	Output Shaft	NT09S-1274	1
4.	Screw	NT09S-1275	4
5.	Gear Case Cover	NT09S-1276	1
6.	Ball Bearing	NT09S-1277	1
7.	Wave Spring Washer	NT09S-1278	1
8.	Circlip for Holes	NT09S-1279	1
9.	Gear Washer	NT09S-1280	1
10.	Side Handle	NT09S-1281	1
11.	Gear	NT09S-1282	1
12.	Oil-impregnated Bearing	NT09S-1283	2
13.	Spindle-Lock Pin	NT09S-1284	1
14.	Case Plastic Cover	NT09S-1285	1
15.	Plastic Screw	NT09S-1286	2
16.	Lock Pin Cap	NT09S-1287	1
17.	Pin Spring	NT09S-1288	1
18.	Screw	NT09S-1289	4
19.	Gear Case	NT09S-1290	1
20.	Screw	NT09S-1291	2
21.	Gear Shaft	NT09S-1292	1
22.	Ball Bearing	NT09S-1293	1
23.	Bevel Gear	NT09S-1294	1
24.	Rubber Seal Ring	NT09S-1295	1
25.	Bearing Retainer	NT09S-1296	1
26.	O-Ring	NT09S-1297	1
27.	Ball Bearing	NT09S-1298	1

No.	Description	Part No.	Q'ty
28.	Armature	NT09S-1299	1
29.	Magnetic Ring	NT09S-1300	1
30.	Ball Bearing	NT09S-1301	1
31.	Rubber Bearing Seat	NT09S-1302	1
32.	Windshield	NT09S-1303	1
33.	Screw	NT09S-1304	2
34.	Lead	NT09S-1305	1
35.	Field Coil	NT09S-1306	1
36.	Field Coil Case	NT09S-1307	1
37.	Data Label	NT09S-1308	1
38.	Carbon Brush Holder	NT09S-1309	1
39.	Screw	NT09S-1310	6
40.	Carbon Brush	NT09S-1311	2
41.	Rear Handle (Right)	NT09S-1312	1
42.	Screw	NT09S-1313	2
43.	Screw	NT09S-1314	5
44.	Cord Jacket	NT09S-1315	1
45.	Power Supply Cord	NT09S-1316	1
46.	Cord Clamp	NT09S-1317	1
47.	Switch	NT09S-1318	1
48.	Rear Handle (Left)	NT09S-1319	1
49.	Controller Assembly	NT09S-1320	1
50.	Coil Spring	NT09S-1321	2
51.	Brand Label	NT09S-1322	1
52.	Speed Label	NT09S-1323	1
53.	Wrench	NT09S-1324	1
54.	O-Ring 5x0.5	NT09S-1325	1

Other languages:

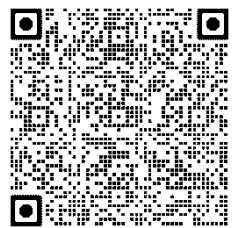

info@onetech-tools.com



www.onetech-auto.com
www.onetech-tools.com

